



海目（北京）激光与数控发展有限公司

Beijing HM Laser Co., LTD

P Series Laser Tube Power Supply User Manual

P 系列激光管电源说明书

I . Main features

- Unique design with several patents
- High intelligence: built-in control, can communicate with motion controller, and it can communicate with max 32pcs power supplies by cascade connecting, then the controller panel can display working condition of power supply, very easy for user to monitor and judge the fault.
- Make the maintenance much easier: User can judge the problem by himself.
- Multi-function LCD screen: One LCD screen can show the information of two power supplies, easy use for multi-head machine.
- Universal: with PFC function, AC90-250V input voltage range, globally universal.
- Open circuit protection: When the high voltage end is in open circuit or not connected well, the power supply will start automatic protection, to prevent high voltage arc effectively.
- More safety: with high voltage discharge function, no residual voltage when turning off, safer for user.
- Excellent cover with patent design: Good appearance, better heat dissipation.
- Improved current control mode, more stable laser, better compatibility.

II. Main specifications

Item		P2	P4	P6
Input	Input voltage	AC90-250V		
	AC frequency	47---440Hz		
	Max input power	500W	700W	900W
	Max input current (when 90V input)	6A	8A	10A
Output	Max output voltage	40KV	45KV	55KV
	Max output current	28mA	32mA	38mA
Efficiency	≥90%(when full load)			
MTBF	≥10000 hours			
Response speed	≤1mS(the time from the signal is given to output current reaches 90% of set current)			
Switch control mode	TTL			
Power control mode	PWM(>20KHz) or 0-5V or 0-3.3V analogue			
Communication mode	Special serial port			
Withstand voltage	Input-output, input-shell:AC1500V 10mA 60s;			
Working environment	Temperature (-10~40) °C, relative humidity:≤90%			
Cooling	Force air cooling			
Dimension	L*W*H(mm)	235*144*104	278*144*104	330*144*104
Weight	(KG)	2.15kg	2.45kg	3.2kg
Color	Silver			

III. Terminal definition

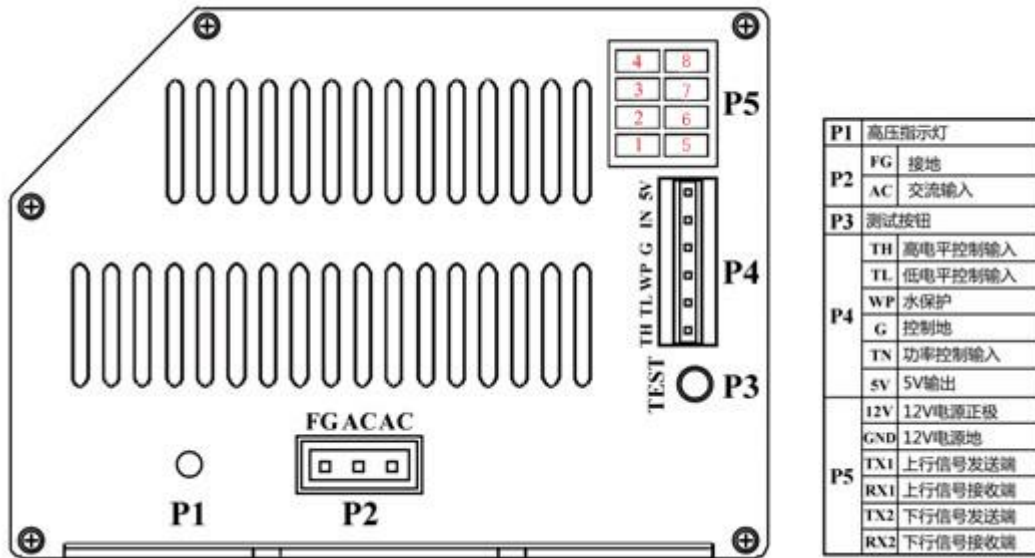

P5 terminal definition

12V	Input signal	12V power anode
GND	Input signal	12V power ground
TX1	Input signal	Uplink signal sending end
RX1	Ground	Uplink signal receiving end
TX2	Power signal	Down link signal sending end
RX2	Output power	Down link signal receiving end

P4 terminal definition

TH	Input signal	Laser on/off control, laser on when high level($\geq 3V$), laser off when low level($\leq 0.3V$)
TL	Input signal	Laser on/off control, laser off when high level($\geq 3V$), laser on when low level($\leq 0.3V$)
WP	Input signal	Laser on/off control, laser off when high level($\geq 3V$), laser on when low level($\leq 0.3V$)
G	Signal ground	This terminal must be connected with outer shell and control board of machine properly.
IN	Power signal	Laser power control terminal, control with 0-5V analog signal or 5V PWM signal
5V	Output	5V output, max output current is 20mA

IV. Connecting method of P5 terminals:

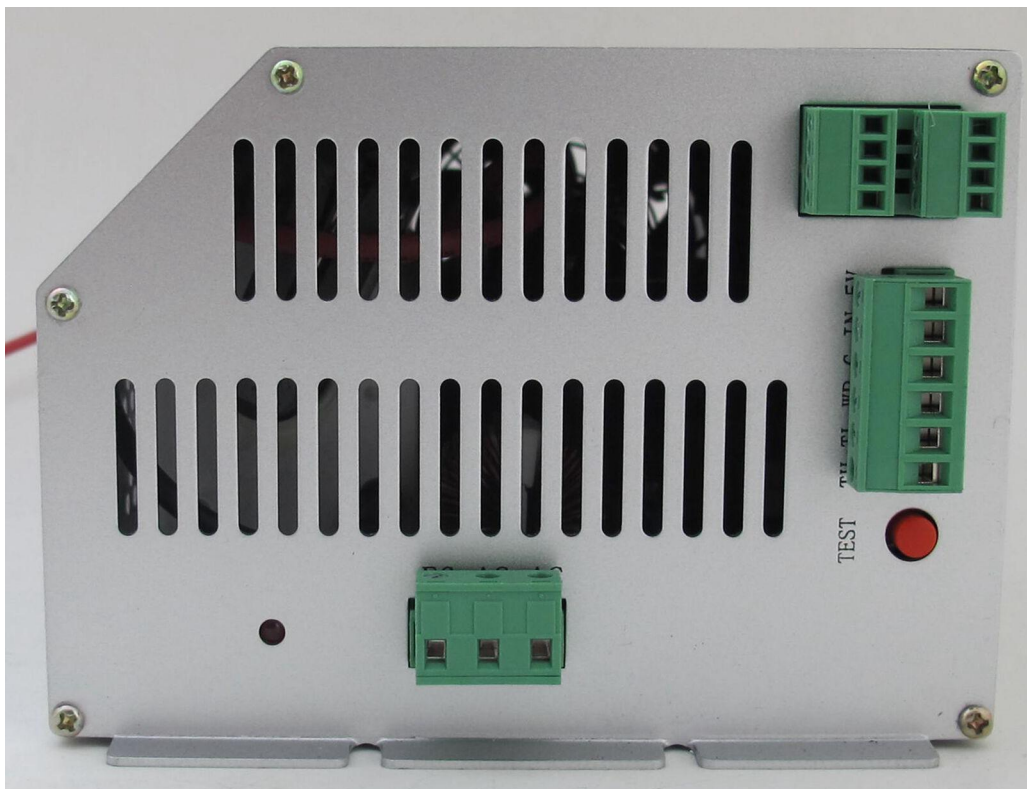
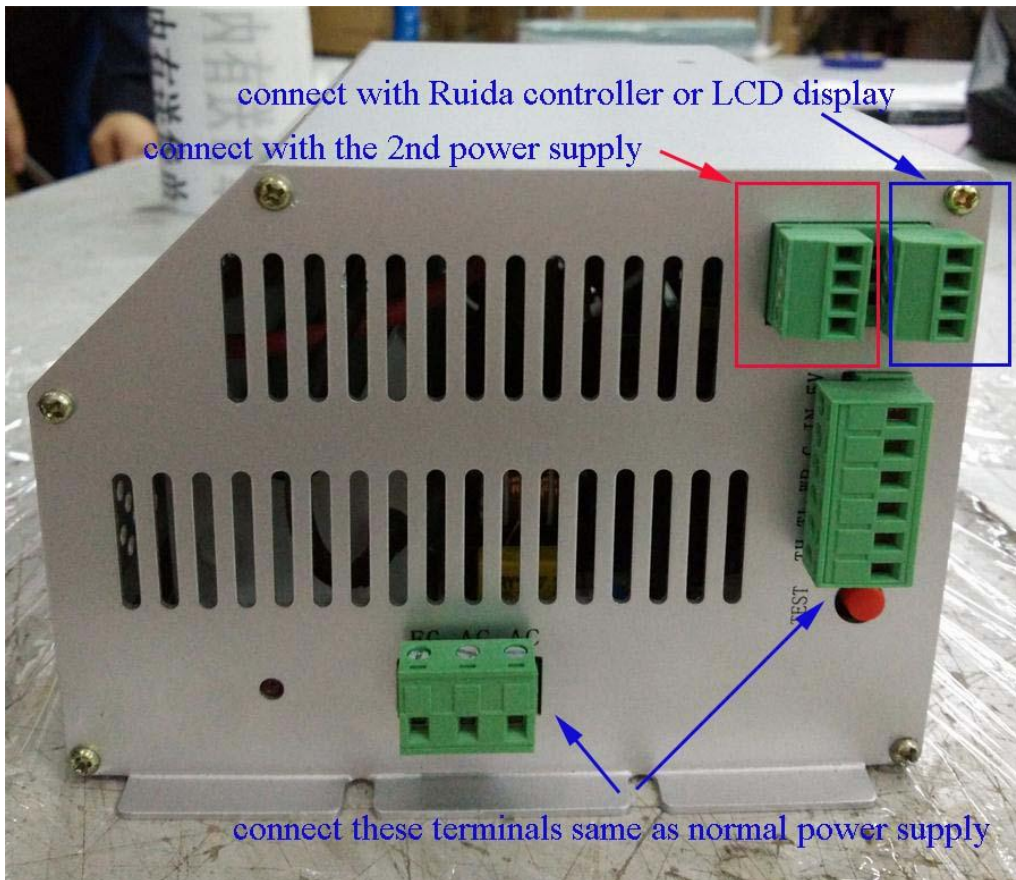

1. If P5 terminals connect with Ruida controller (please see sketch 1 and 2):
Sketch 1:

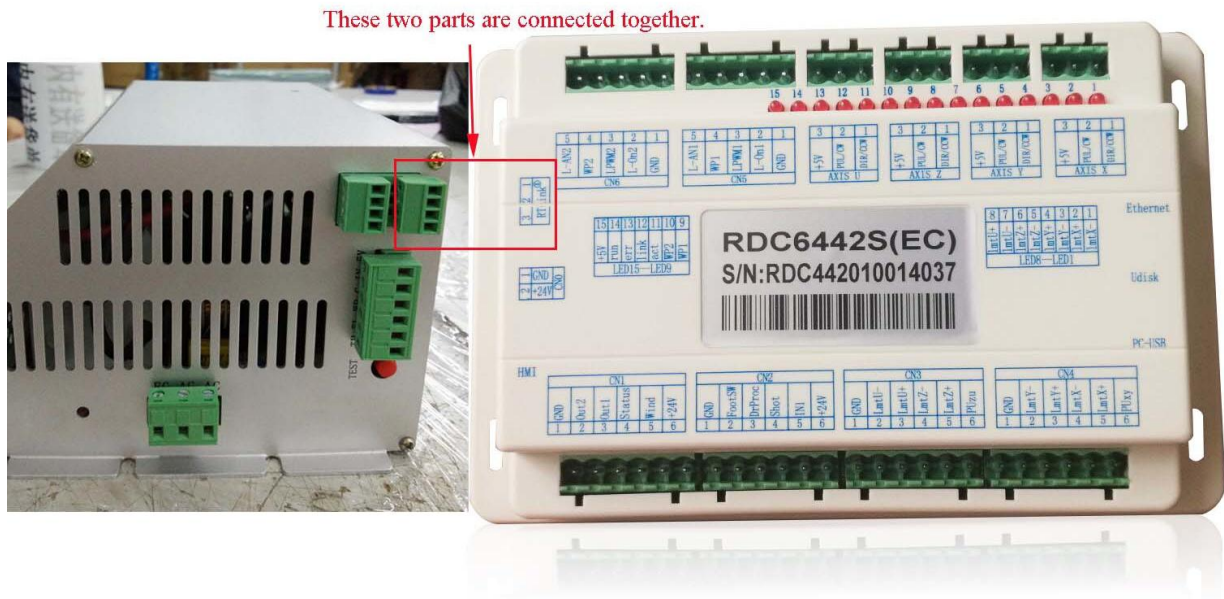

In this step, the connecting method is like this:

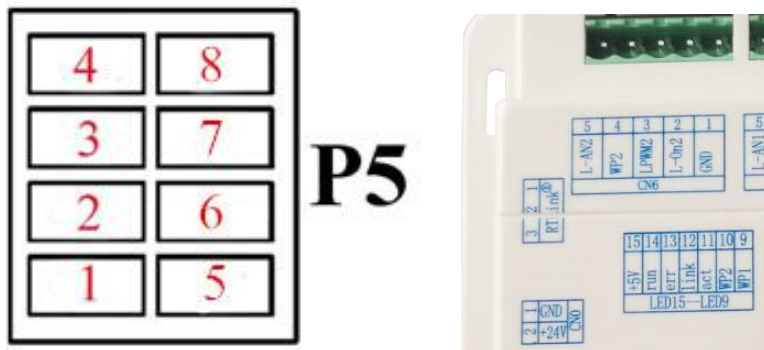

- 1 of controller connects 7 of PSU.
- 2 of controller connects 8 of PSU.
- 3 of controller connects 6 of PSU.

Sketch 2:

The left terminal of 1st PSU can be empty if there is only 1 PSU.

If there are more than 2 PSU, it connects with right terminal of 2nd PSU

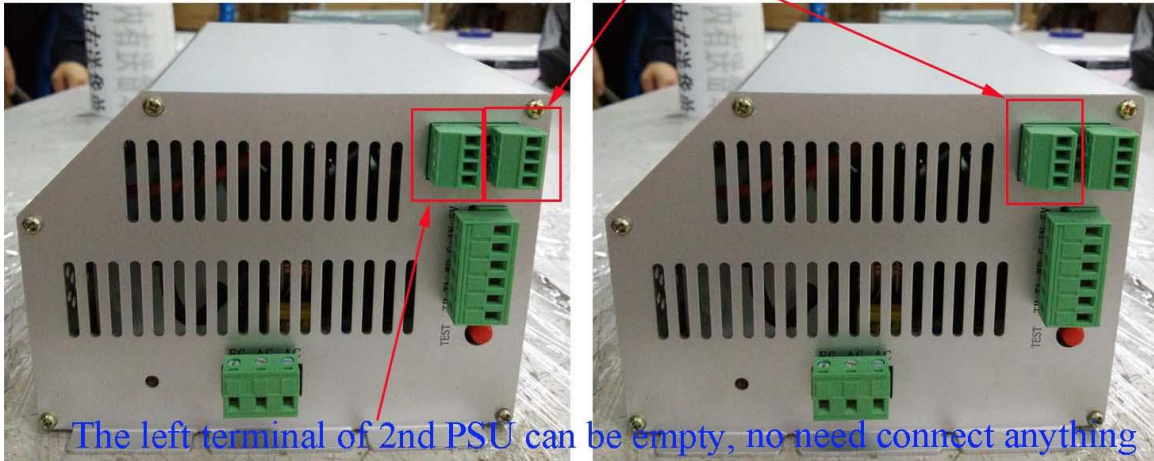

second power supply

first power supply

In this step, the connecting method is like this:

2 of 1st PSU connects 6 of 2nd PSU.

3 of 1st PSU connects 7 of 2nd PSU.

4 of 1st PSU connects 8 of 2nd PSU.

1: no need to connect

2. If P5 terminals connect with LCD display:

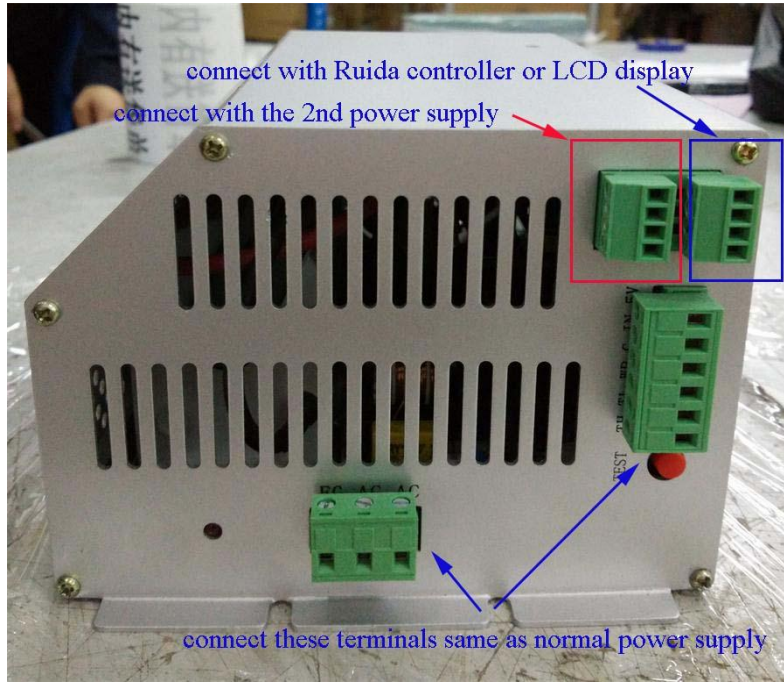

V. Display information

1. Display when connecting Ruida controller:

This area will display the fault information if there is fault. If all is normal, no information here.

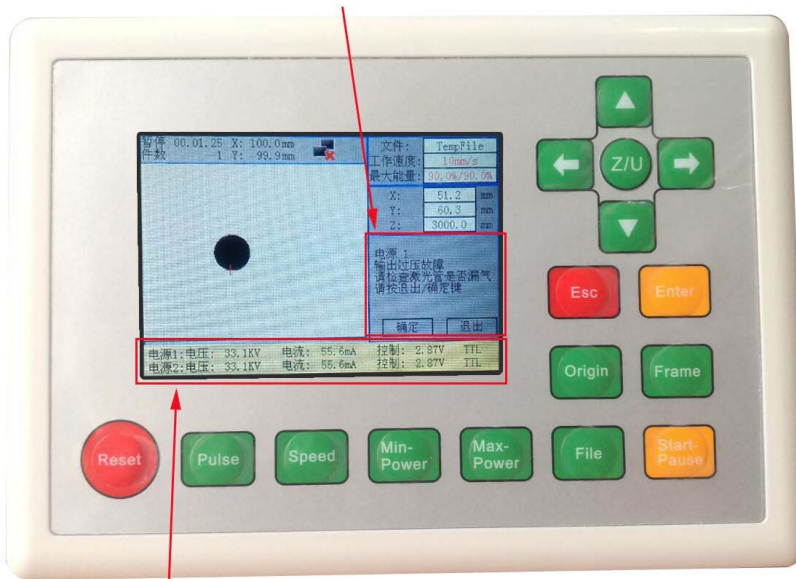

The bottom of the panel will display the working conditions of power supply, such as voltage, current, etc.

2. Display when connecting LCD screen:

(1) Display for single PSU

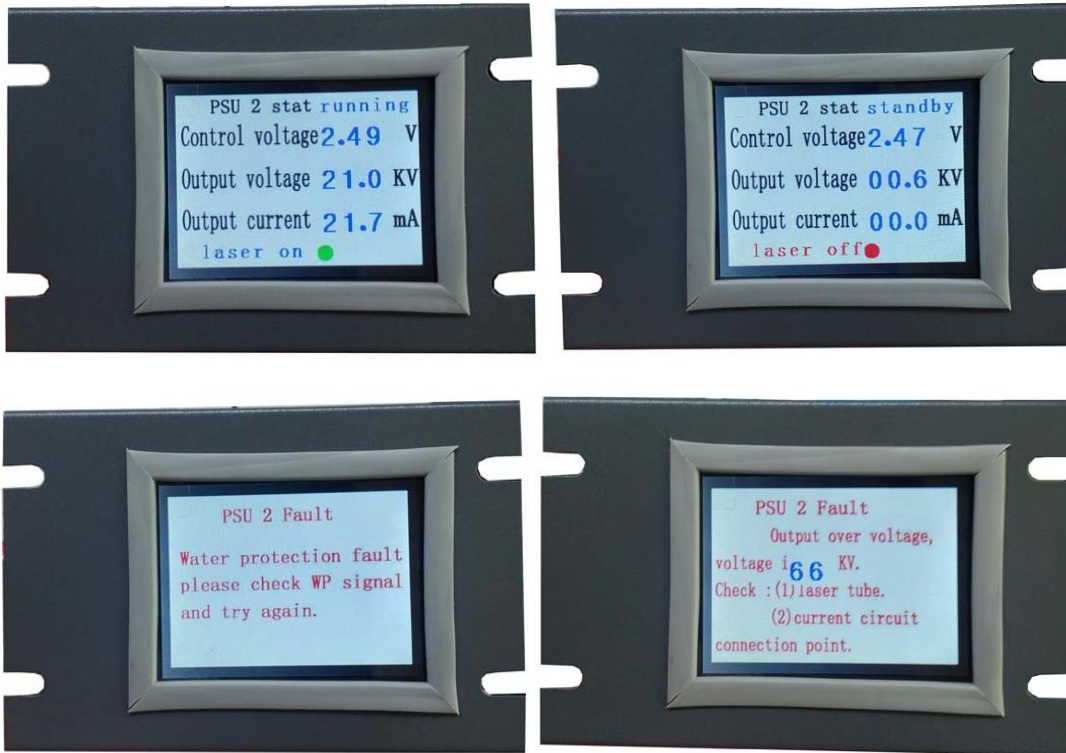

(2)Display for double sets PSU

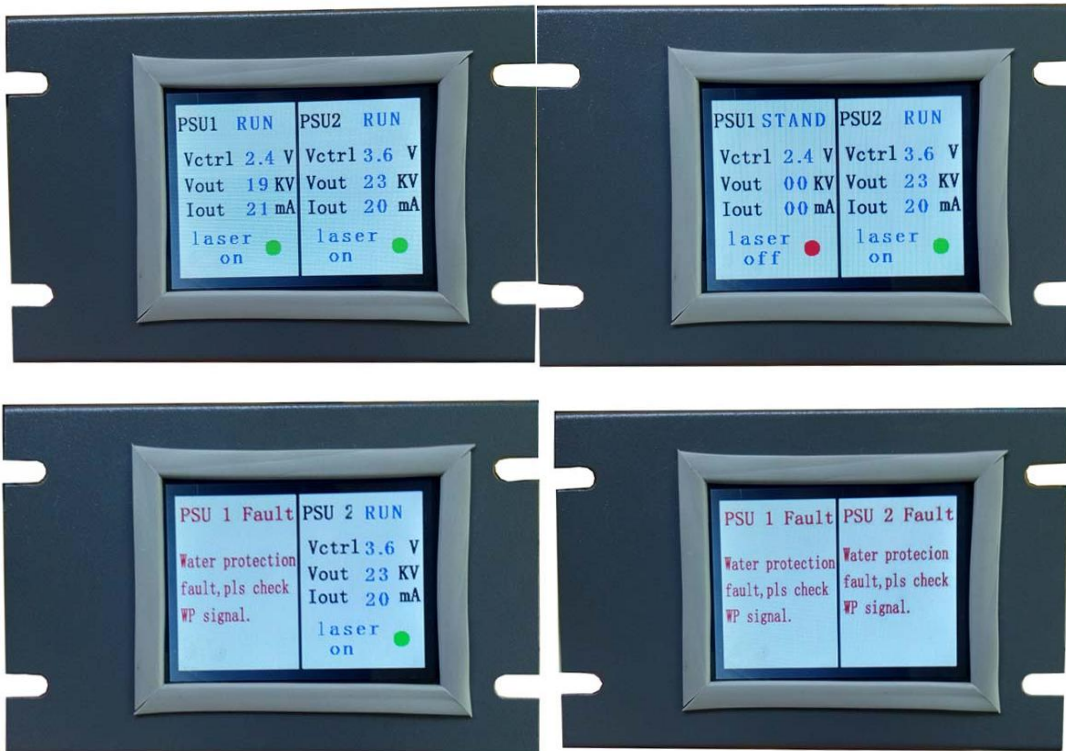

VI. Installation size

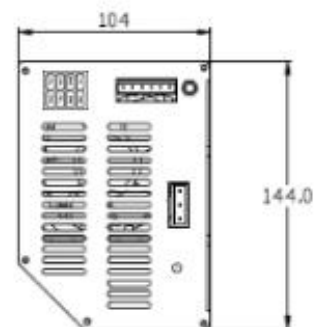
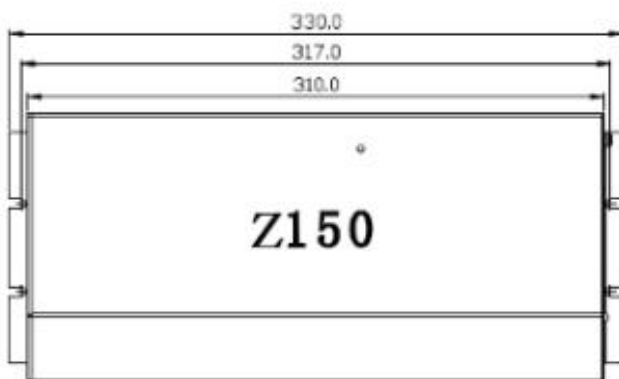
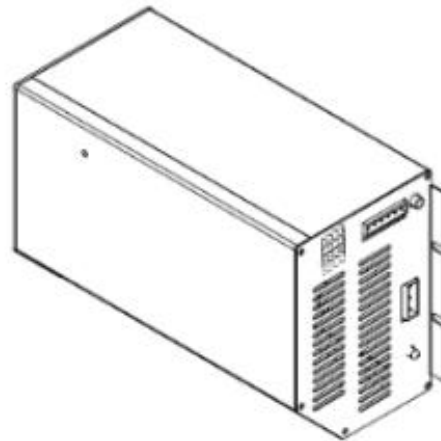
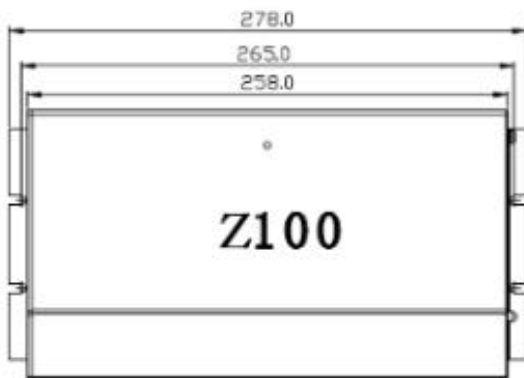
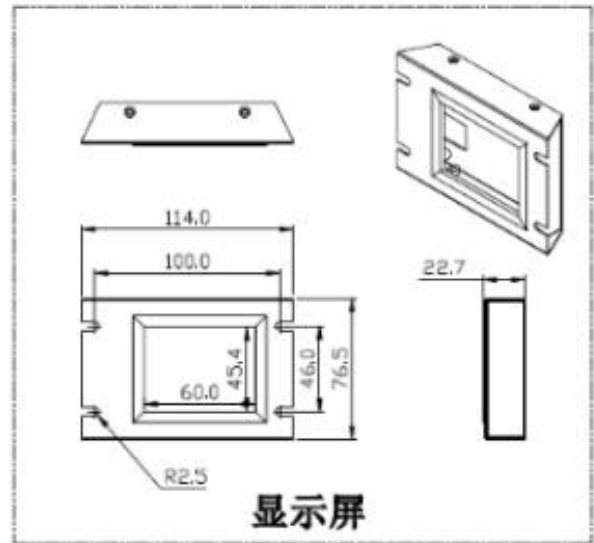
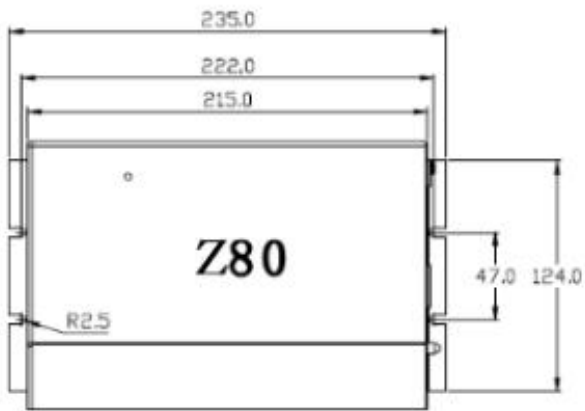

Remarks: The hole distances of three models are same.